

# JUICE

STEREO POWER AMPLIFIERS

owner's manual

J•800  
J•1400  
J•2500



TOTAL AUDIO PRODUCTION

## SAFETY INSTRUCTIONS

1. Read these instructions.
2. Keep these instructions.
3. Heed all warnings.
4. Follow all instructions.
5. Do not use this apparatus near water.
6. Clean only with a dry cloth.
7. Do not block any ventilation openings. Install in accordance with the manufacturer's instructions.
8. Do not install near any heat sources such as radiators, heat registers, stoves, or other apparatus (including amplifiers) that produce heat.
9. Do not defeat the safety purpose of the polarized or grounding-type plug. A polarized plug has two blades with one wider than the other. A grounding-type plug has two blades and a third grounding prong. The wide blade or the third prong are provided for your safety. If the provided plug does not fit into your outlet, consult an electrician for replacement of the obsolete outlet.
10. Protect the power cord from being walked on or pinched particularly at plugs, convenience receptacles, and the point where they exit from the apparatus.
11. Only use attachments/accessories specified by the manufacturer.
12. Use only with a cart, stand, tripod, bracket, or table specified by the manufacturer, or sold with the apparatus. When a cart is used, use caution when moving the cart/apparatus combination to avoid injury from tip-over.

13. Unplug this apparatus during lightning storms or when unused for long periods of time.
14. Refer all servicing to qualified service personnel. Servicing is required when the apparatus has been damaged in any way, such as when the power-supply cord or plug has been damaged, liquid has been spilled or objects have fallen into the apparatus, the apparatus has been exposed to rain or moisture, does not operate normally, or has been dropped.
15. This apparatus shall not be exposed to dripping or splashing, and no object filled with liquids, such as vases, shall be placed on the apparatus.
16. This apparatus has been designed with Class-I construction and must be connected to a mains socket outlet with a protective earthing connection (the third grounding prong).
17. This apparatus has been equipped with a single-pole rocker-style AC mains power switch. This switch is located on the front panel and should remain readily accessible to the user.
18. This apparatus does not exceed the Class A/Class B (whichever is applicable) limits for radio noise emissions from digital apparatus as set out in the radio interference regulations of the Canadian Department of Communications.

ATTENTION –Le présent appareil numérique n'émet pas de bruits radioélectriques dépassant les limites applicables aux appareils numériques de class A/de class B (selon le cas) prescrites dans le règlement sur le brouillage radioélectrique édicté par les ministères des communications du Canada.

### PORTABLE CART WARNING



Carts and stands - The Component should be used only with a cart or stand that is recommended by the manufacturer. A Component and cart combination should be moved with care. Quick stops, excessive force, and uneven surfaces may cause the Component and cart combination to overturn.

### CAUTION AVIS



RISK OF ELECTRIC SHOCK  
DO NOT OPEN  
RISQUE DE CHOC ELECTRIQUE  
NE PAS OUVRIR



**CAUTION: TO REDUCE THE RISK OF ELECTRIC SHOCK  
DO NOT REMOVE COVER (OR BACK)  
NO USER-SERVICEABLE PARTS INSIDE  
REFER SERVICING TO QUALIFIED PERSONNEL**

ATTENTION: POUR EVITER LES RISQUES DE CHOC ELECTRIQUE, NE PAS ENLEVER LE COUVERCLE. AUCUN ENTRETIEN DE PIECES INTERIEURES PAR L'USAGER. CONFIER L'ENTRETIEN AU PERSONNEL QUALIFIE.

AVIS: POUR EVITER LES RISQUES D'INCENDIE OU D'ELECTROCUTION, N'EXPOSEZ PAS CET ARTICLE A LA PLUIE OU A L'HUMIDITE



The lightning flash with arrowhead symbol within an equilateral triangle is intended to alert the user to the presence of uninsulated "dangerous voltage" within the product's enclosure that may be of sufficient magnitude to constitute a risk of electric shock to persons.

Le symbole éclair avec point de flèche à l'intérieur d'un triangle équilatéral est utilisé pour alerter l'utilisateur de la présence à l'intérieur du coffret de "voltage dangereux" non isolé d'ampleur suffisante pour constituer un risque d'électrocution.



The exclamation point within an equilateral triangle is intended to alert the user of the presence of important operating and maintenance (servicing) instructions in the literature accompanying the appliance.

Le point d'exclamation à l'intérieur d'un triangle équilatéral est employé pour alerter les utilisateurs de la présence d'instructions importantes pour le fonctionnement et l'entretien (service) dans le livret d'instruction accompagnant l'appareil.

**WARNING — To reduce the risk of fire or electric shock, do not expose this appliance to rain or moisture.**

19. Exposure to extremely high noise levels may cause permanent hearing loss. Individuals vary considerably in susceptibility to noise-induced hearing loss, but nearly everyone will lose some hearing if exposed to sufficiently intense noise for a period of time. The U.S. Government's Occupational Safety and Health Administration (OSHA) has specified the permissible noise level exposures shown in the following chart.

According to OSHA, any exposure in excess of these permissible limits could result in some hearing loss. To ensure against potentially dangerous exposure to high sound pressure levels, it is recommended that all persons exposed to equipment capable of producing high sound pressure levels use hearing protectors while the equipment is in operation. Ear plugs or protectors in the ear canals or over the ears must be worn when operating the equipment in order to prevent permanent hearing loss if exposure is in excess of the limits set forth here.

Duration Per Day In Hours	Sound Level dBA, Slow Response	Typical Example
8	90	Packed garage concert
6	92	
4	95	VW Bus Peace Train
3	97	
2	100	Cranked psychedelic tunes
1.5	102	
1	105	High speed chase on C.H.I.P.s
0.5	110	
0.25 or less	115	Loudest parts at a Heavy Metal concert

## What me, read a manual?

Before you begin, please make sure you read the Safety Instructions on page 2 and Getting Started on page 4.

Your new TAPCO® amplifier is designed to set up quickly and operate easily. We know it's often seen as a sign of weakness to read a manual, along with asking for directions when lost, but maybe you can read the rest when nobody is looking.

It is important to keep your receipt in a safe place, and not a bad idea to write your product information here for future reference (i.e., insurance claims, tech support, return authorization, etc.).

**Product Serial #:**

**Purchased at:**

**Date of purchase:**



# Getting Started

The following steps will help you set up your amplifier, and get the levels just right.

## SETTINGS:

1. Be sure the amplifier's POWER switch is off.
2. Turn down both Level controls.
3. On the rear panel, set the SUBSONIC FILTER switch OFF and the CLIP LIMIT switch ON.
4. Determine which AMP MODE is best for your application:  
STEREO mode is the typical setup for amplifying stereo signals. INPUT 1 is routed to CHANNEL 1 output, and INPUT 2 is routed to CHANNEL 2 output.  
MONO mode is used for sending a mono signal to both outputs, with separately adjustable level controls. INPUT 1 is used in MONO mode (leave INPUT 2 disconnected).  
BRIDGE mode uses both outputs to double the power to one speaker (or set of speakers). INPUT 1 is used in BRIDGE mode (leave INPUT 2 disconnected and the B Level control turned down).  
**NOTE:** 4 ohms is the minimum speaker impedance you should connect to the amplifier in BRIDGE mode. See "Do the Math" in Appendix B for information on calculating speaker impedances.
5. Set the AMP MODE switch according to your application.

## CONNECTIONS:

1. Using balanced cables, make connections from your mixer (or other signal source) MAIN OUT to your amplifier's INPUTS.
2. In STEREO mode, connect the cables from your signal source to the amplifier's INPUT jacks, either XLR or 1/4" TRS.
  - The XLR and TRS inputs for each channel are wired in parallel.
  - The balanced XLR inputs are wired as follows:  
Pin 1 = shield (ground)  
Pin 2 = hot (+)  
Pin 3 = cold (-)
  - The 1/4" TRS inputs are wired as follows:  
Tip = hot (+)  
Ring = cold (-)  
Sleeve = shield (ground)
3. In MONO mode and BRIDGE mode, connect one cable from the input source to INPUT 1, and connect nothing to INPUT 2.

4. In STEREO and MONO modes, connect speaker cables to the SPEAKER OUTPUTS, either the binding posts or the Speakon® connectors.
  - The binding post connectors are wired as follows:  
red = hot (+ speaker terminal)  
black = cold (- speaker terminal)
  - The Speakon connectors are wired as follows:  
1+ = hot (+ speaker terminal)  
1- = cold (- speaker terminal).
5. In BRIDGE mode, if using the binding post outputs:
  - CHANNEL 1 SPEAKER OUTPUT red post = hot (+ speaker terminal)
  - CHANNEL 2 SPEAKER OUTPUT red post = cold (- speaker terminal)Do not use the black terminals.  
If using a Speakon connector, connect the Speakon to the center BRIDGED connector.
  - The BRIDGED Speakon connector is wired as follows:  
1+ = hot (+ speaker terminal)  
2+ = cold (- speaker terminal).
6. Plug all the sound system components into suitable AC outlets, properly grounded and capable of delivering adequate current.
7. Make sure your signal source is powered up and delivering signal to the amp.
8. Turn the power amplifier's switch on. Verify that the POWER LED lights.
9. Slowly turn up both Level controls on the amplifier. You should hear music and see the SIG LEDs flashing. If the OL (Overload) LEDs are flashing, turn down either the Level controls on the amp or the source signal's output level controls (i.e., master faders), until the OL LEDs either blink occasionally or not at all.
10. For quieter listening, it is preferable to adjust the amp's Level controls rather than the source signal's output level (unless you have the source's control all the way up!).

## Things To Remember:



- Never plug amplifier outputs into anything except speakers (unless you have an outboard box specifically designed to handle speaker-level signals).

- Before making connections to an amp or reconfiguring an amp's routing, turn the amp's level controls down, turn the power off, make the changes, turn the power back on, and then turn the level controls back up.
- If you shut down your equipment, turn off the amplifiers first. When powering up, turn on the amplifiers last.
- Save the shipping box and packing material! You may need it someday. If not, it makes a great end table or hiding place for your cat.

# Contents

SAFETY INSTRUCTIONS.....	2
Getting Started.....	4
Introduction .....	6
Hookup Diagrams .....	7
TAPCO Juice Features .....	8
FRONT PANEL FEATURES .....	8
1. Level.....	8
2. SIG .....	8
3. OL.....	8
4. POWER.....	8
REAR PANEL FEATURES .....	8
5. Power Cord Socket .....	8
6. BREAKER.....	9
7. SPEAKER OUTPUTS .....	9
8. INPUTS .....	9
9. SUBSONIC FILTER .....	9
10. CLIP LIMIT .....	9
11. AMP MODE .....	9
GENERAL PRECAUTIONS.....	9
Rack Mounting .....	9
Thermal Considerations .....	10
AC Power Considerations.....	10
Input Wiring.....	10
Output Wiring .....	11
Appendix A: Service Information.....	14
Warranty Service .....	14
Troubleshooting.....	14
Repair.....	15
Appendix B: Technical Info .....	16
Do The Math: Ohms, Loads, and Such .....	16
Juice Series Specifications .....	17
Juice Series Block Diagram .....	18
TAPCO LIMITED WARRANTY.....	19

Don't forget to visit our website at [www.tapcogear.com](http://www.tapcogear.com) for more information about this and other TAPCO products.

# Introduction

Thank you for choosing a TAPCO® Juice™ power amplifier. The TAPCO product line hails back to the days of TAPCO Corporation, Greg Mackie's first company. TAPCO revolutionized the audio industry in 1969 with the very first 6-channel mixer specifically designed for keyboards and rock 'N' roll PA.

In essence, TAPCO re-defined the price performance ratio and made high-quality professional audio mixers accessible to virtually anyone. Today, TAPCO is reborn with the same ideals and is backed by the world-class engineering and manufacturing horsepower of Mackie. The TAPCO J•800, J•1400, and J•2500 are the first power amplifiers in the TAPCO family.

The Juice Series™ of amplifiers are powerful and tough. They are designed to withstand the punishing rigors of the road and continue to crank out amplified sound day after day, year after year.

Here's a quick glance at the features packed into these juicy amplifiers:

- J•800: 800 watts continuous @ 4 ohms bridged
- J•1400: 1400 watts continuous @ 4 ohms bridged
- J•2500: 2500 watts continuous @ 4 ohms bridged
- Ultra-low noise/low-distortion design
- Switchable low-cut filter @ 30 Hz on both channels
- Switchable limiter on both channels
- Balanced/unbalanced 1/4" TRS and XLR line input jacks
- Speakon® output connectors
- Detented rotary gain controls calibrated in dB
- Signal present and OL (overload) LEDs
- Variable speed fans for superior cooling

# Hookup Diagrams

## Stereo Hookup

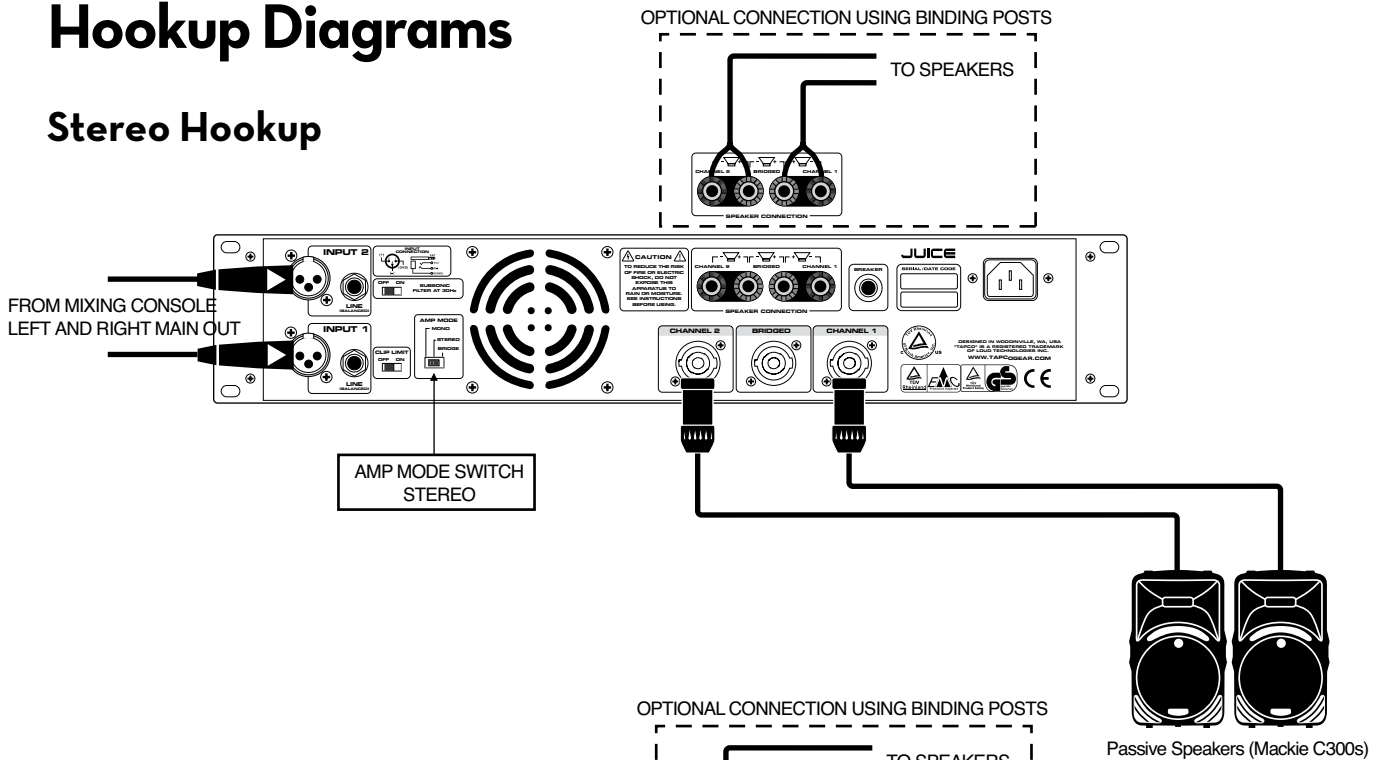

## Mono Hookup

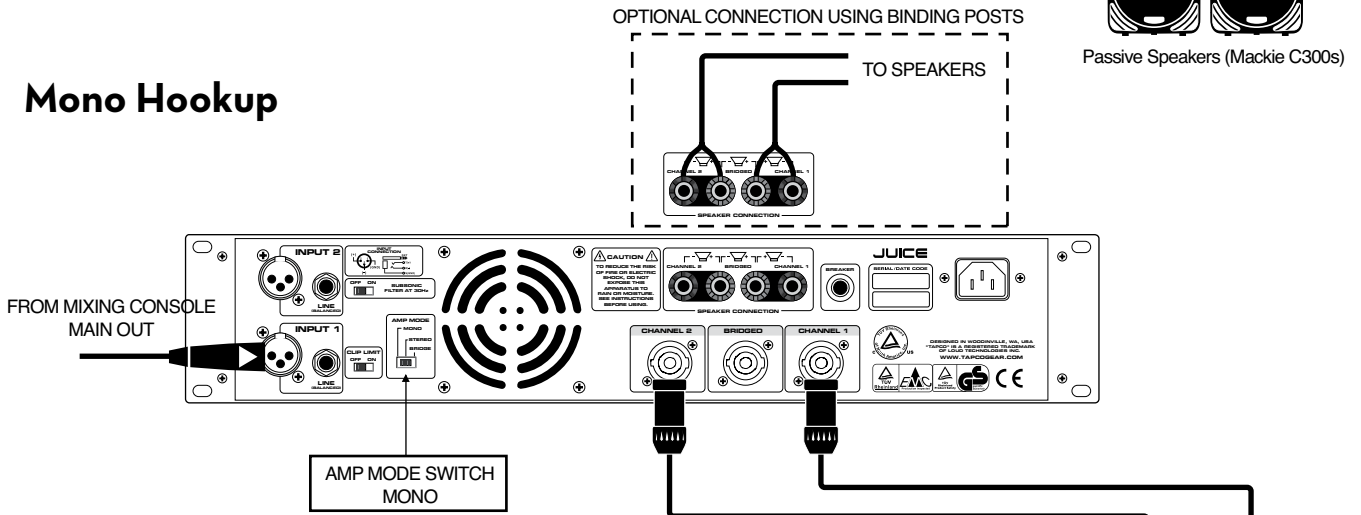

## Bridge Hookup

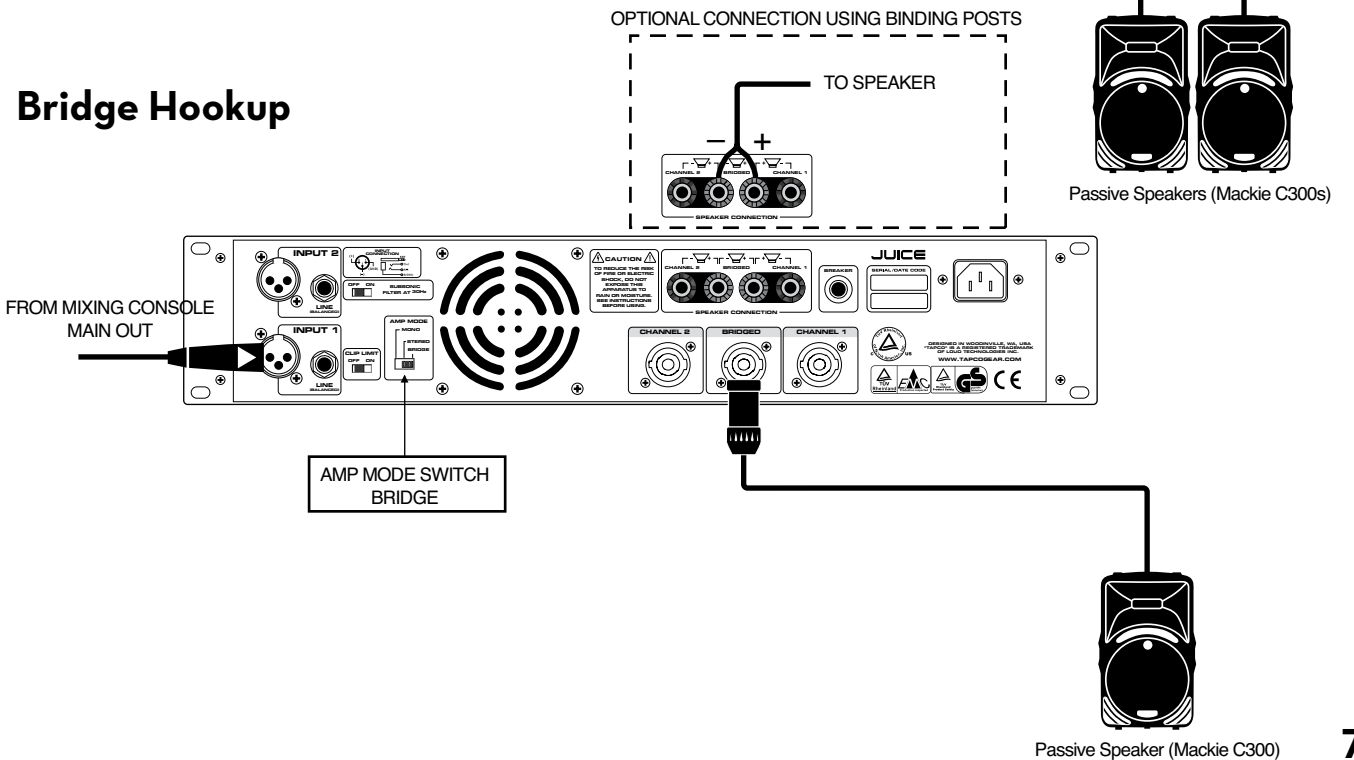

# TAPCO Juice Features

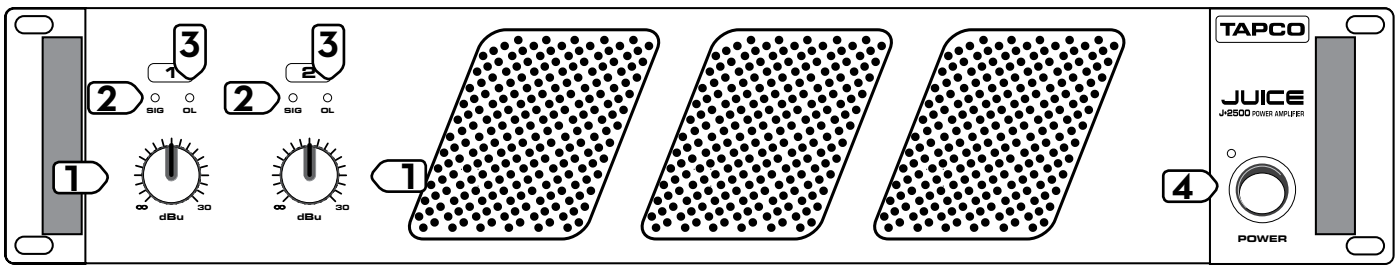

## FRONT PANEL FEATURES

### 1. Level

These two knobs control the levels of Channels 1 and 2. The knobs are detented to make it easy to set both controls to the same level. Usually, these controls are set all the way up.

The amplifiers are designed so that a +3.4 dBu (1.15V rms) input signal drives the amplifier to full power into 4 ohms:

J•800 = 300 watts per channel into 4 ohms

J•1400 = 450 watts per channel into 4 ohms

J•2500 = 750 watts per channel into 4 ohms

This equates to a gain of about 30 dB (30 dB, 32 dB, and 34 dB respectively). The graphics around the knob indicate full gain of (about) 30 dB when the knob is all the way up (fully clockwise).

After you have set the levels for the mixer (or other signal source), adjust the Level controls on the amplifier as the final adjustment to set the overall volume for the system.

### 2. SIG

This is short for “signal present.” These green LEDs indicate when a signal is present after the Level controls, at the output stage of the power amplifier. If the Level controls are turned all the way down (fully counterclockwise), these indicators will not light.

### 3. OL

This is short for “overload.” These red LEDs indicate when the output of the amplifier has reached the maximum, and is right on the hairy edge of clipping. Clipping is bad for speakers and should be avoided.

It is okay if the OL LED blinks occasionally. It means that the transient peaks of the music are just hitting the full output of the amplifier.



However, if the OL (overload) LED is blinking frequently or continuously, turn down the source signal (i.e., the mixer’s master faders) or the amplifier’s Level controls.

### 4. POWER

This handy switch turns the power amplifier on and off. When the amplifier is on, the POWER LED lights to let you know Juice is ready and rarin’ to go!

## REAR PANEL FEATURES

### 5. Power Cord Socket

Here is where you connect the detachable power cord that came in the box with your amplifier. Plug the other end of the power cord into an AC outlet properly configured with the voltage required for your particular model.

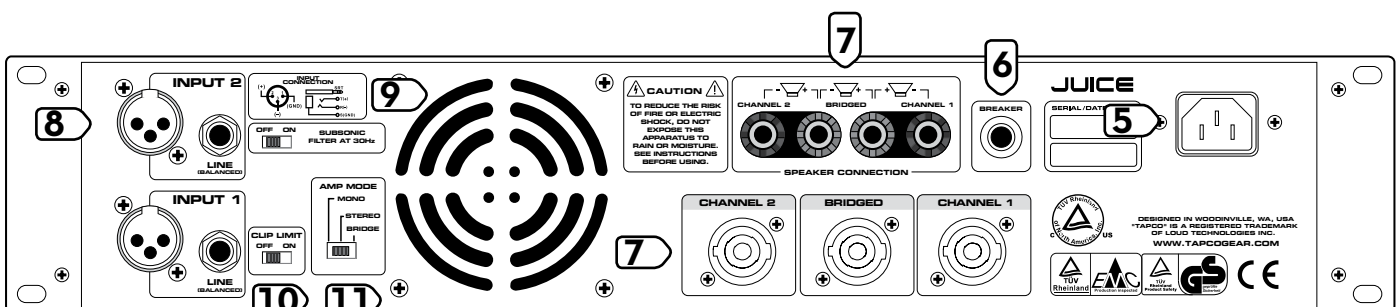



## 6. BREAKER

This is a resettable circuit breaker that monitors the amount of current being drawn by the amplifier. Under normal operating conditions, this should never pop. An unusual condition may cause the breaker to pop, such as a mains voltage surge occurring at the same time as a peak amplifier output.

Turn the POWER switch off, and push the BREAKER button in to reset the circuit breaker. Turn the POWER switch back on and the amplifier should resume normal operation. If the circuit breaker pops again, something probably isn't right.

- Make sure that the total impedance of the speakers connected to the outputs is 2 ohms or greater (per channel) in stereo mode, or 4 ohms or greater in bridged mode.
- If the breaker pops right away, even with the Level controls turned down and the speakers disconnected, there may be something wrong inside the amplifier. Refer to "Appendix A: Service Info."

## 7. SPEAKER OUTPUTS

You have two options for connecting your speakers: binding posts and Speakon connectors.

Normally, you would use either the binding posts or the Speakon connectors. Since the connectors are wired in parallel (e.g., CHANNEL 1 binding post and Speakon are in parallel, and CHANNEL 2 binding post and Speakon are in parallel), you can connect a speaker to each connector, as long as the total impedance per channel is two ohms or more.

- Two 8 ohm speakers in parallel equals 4 ohms.
- Two 4 ohm speakers in parallel equals 2 ohms.

See "Output Wiring" on page 11 for information on output connection wiring.

## 8. INPUTS

The Juice amplifiers give you two options for connecting the input signal – XLR input connectors and 1/4" TRS (Tip-Ring-Sleeve) connectors. These inputs are in parallel, and are identical, electrically speaking. You can connect either a balanced or an unbalanced signal here.

Since these two inputs are in parallel, you shouldn't connect more than one source to the INPUT 1 or INPUT 2 jacks. However, you can use the unused input jack as a "Thru" connector, to daisy-chain the signal to another amplifier. See "Input Wiring" on page 10 for information on input connection wiring.

## 9. SUBSONIC FILTER

Turn this switch on to engage a low-frequency cutoff (high-pass) filter at 30 Hz. The Juice amplifiers can amplify signals below 20 Hz, but

most speakers can't reproduce frequencies that low. By engaging the SUBSONIC FILTER, you allow the amplifier to power only the frequencies that you can hear. In addition, this filter can remove low-frequency stage noise (footsteps) and accidental microphone pops that could damage a loudspeaker.

## 10. CLIP LIMIT

The CLIP LIMIT switch is there to protect your loudspeakers from the effects of clipping. It is designed to be virtually transparent, meaning you probably won't even notice any audible difference when the switch is turned on.

We recommend that you leave this switch on at all times. However, if you are working at quiet levels, or you have already placed a compressor/limiter in the signal path, you can leave the CLIP LIMIT switch off.

## 11. AMP MODE

This switch determines the input signal routing within the amplifier. For most applications, you will use the STEREO setting. However, some applications might be better suited for using either the MONO or the BRIDGE setting.

**STEREO:** This mode accepts separate left and right inputs (A and B), and routes them to the CHANNEL 1 and CHANNEL 2 outputs. Each channel's Level control adjusts the gain for its own channel.

**MONO:** This mode accepts a single input (INPUT 1), and routes it to both the CHANNEL 1 and CHANNEL 2 outputs. Each channel's Level control adjusts the gain for its own channel.

**BRIDGE:** This mode accepts a single input (INPUT 1), and uses both amplifier outputs to double the power to one speaker (or set of speakers). Use the CHANNEL 1 Level control to adjust the gain (turn the CHANNEL 2 Level control all the way down). See "Output Wiring" on page 11 for information on how to connect a speaker in Bridge mode.

## GENERAL PRECAUTIONS AND CONSIDERATIONS

### Rack Mounting

The Juice amplifiers are designed to be mounted in a standard rack. They require two rack spaces (2U = 3.5"). They also require 15.75" depth inside the rack, including the rear support brackets. When designing your rack, put the heavier items at the bottom and the lighter items toward the top.

Secure the front panel of the amplifier to the front of the rack using four screws with soft washers to prevent scratching the panel. In addition, because of the weight of the amplifier, you must secure the rear support brackets of the amplifier to the back of the rack. You could use a support rail or

shelf across the back of the rack, or angle brackets attached between the rear support rails and the rear rails of the rack. This is recommended for all components mounted in a rack that is going to be moved frequently (or thrown in the back of a pickup truck and transported down a bumpy gravel road to that outdoor festival!).

## Thermal Considerations

The Juice amplifiers are fan-cooled with two separate fans. One fan brings cool air in from the back and the other fan blows the warm air out the front of the chassis. Make sure that cool air is available at the back of the amplifier, and that there is room in the front for the warm air to exit from the amplifier and dissipate. If rack-mounted, make sure the air being drawn from the rack is cool. Some rack-mounted equipment expel warm air into the rack.

When the amplifier is first turned on, the fans run at low speed. As the power output increases and the amp warms up, the fans gradually increase in speed to provide additional cooling.

## AC Power Considerations

Be sure the amplifier is plugged into an AC outlet that is able to supply the specified voltage. Be sure the AC outlet can supply enough current to allow full power operation of all the amplifiers plugged into it. The outlet should be a three-prong socket that matches the power cord.



**WARNING:** Bypassing the plug's safety ground pin can be dangerous. **Don't do it!**

The AC current demand of an amplifier varies depending on several factors, including the load impedance, the crest factor, and the duty cycle of the program material. Under typical conditions reproducing rock music where musical peaks are just below clipping, the Juice amplifiers require the following average currents.

J•800 = 5 A

J•1400 = 7 A

J•2500 = 10 A

It is recommended that a stiff supply of AC power be used because the amplifier places high current demands on the AC line. The more power that is available on the line, the louder the amplifier will play and the more peak output power will be available for cleaner, punchier bass.

If you have more than one amplifier sharing an AC outlet, you should avoid turning them all on at the same time. Rather, sequence them on, one at a time, to prevent popping the circuit breaker (due to in-rush current).

## Input Wiring

Use a high-quality 3-conductor shielded cable to connect the signal between the signal source (mixing console, equalizer, etc.) and the balanced inputs to the amplifier. If you are using unbalanced inputs, use a high-quality 2-conductor shielded cable. Your TAPCO Dealer can recommend a suitable cable for your application.

When connecting a balanced signal, the connectors are wired thusly, according to the AES (Audio Engineering Society) standards:

	XLR	TRS
Hot (+)	Pin 2	Tip
Cold (-)	Pin 3	Ring
Shield (Gnd)	Pin 1	Shield

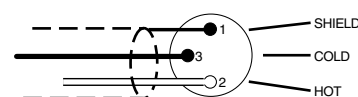
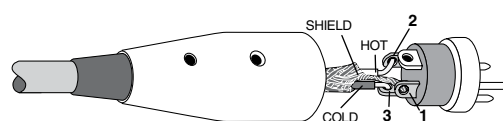

Balanced XLR Connector

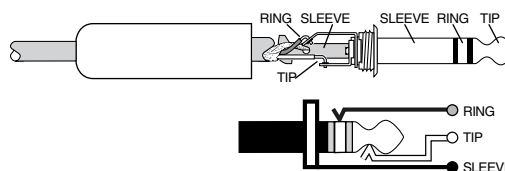

Balanced 1/4" TRS Plug

Unbalanced TS (Tip-Sleeve) lines can be accommodated via the TRS jack. Make sure the cord terminates with a TS plug (like a guitar plug), or if it is a TRS plug (like a headphone plug), make sure the ring is tied to the shield, preferably at the source.

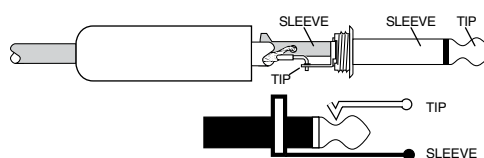

Unbalanced 1/4" TS Plug



If you set the AMP MODE switch to MONO or BRIDGE, use the INPUT 1 input only.

### Using the 1/4" TRS INPUT 1s a "Thru" Connector

Because the XLR connector and the 1/4" TRS connector are in parallel, you can use the 1/4" TRS jack as a "Thru" connector to pass the input signal on to another amplifier's input (see Figure below).



**Note:** If you use an unbalanced 1/4" TS cable to daisy-chain the TRS input jack to another amplifier, you will unbalance the XLR input on the Juice amplifier. This negates the benefits associated with balanced lines and inputs.

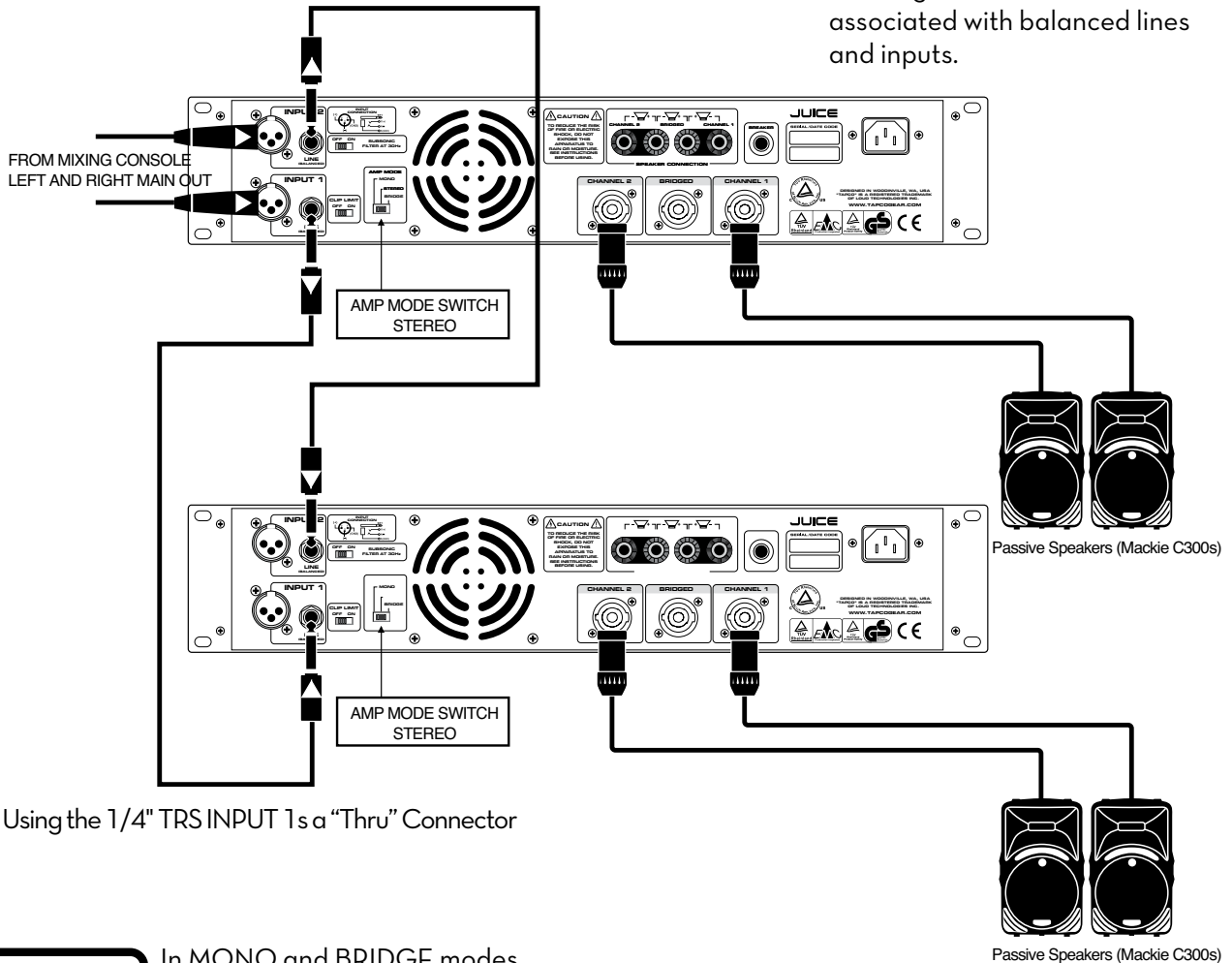

Using the 1/4" TRS INPUT 1s a "Thru" Connector



In MONO and BRIDGE modes, INPUT 1 and INPUT 2 are connected together in parallel. This allows you to use INPUT 2 as a "Thru" connector to daisy-chain the input signal to another amplifier.

### Output Wiring

Use heavy gauge, stranded wire for connecting speakers to the Speakon outputs jacks. As the distance between the amplifier and the speakers increases, the thickness of the wire should also increase. Speaker wire has resistance, and when electricity passes through a resistor, power is lost. The thicker the wire, the less resistance it offers, and the more power actually gets to the speaker.

The thickness of the wire is rated in gauges. Use the chart at the right to determine the correct gauge of wire to use according to the distance between the speakers and the amplifier, and the impedance of the load the amplifier is driving. This ensures that the power lost across the speaker wire is less than 0.5 dB.

Wire Length	Load Impedance	Gauge of Wire
Up to 25 ft.	2Ω	14 gauge
	4Ω	16 gauge
	8Ω	18 gauge
Up to 40 ft.	2Ω	12 gauge
	4Ω	14 gauge
	8Ω	18 gauge
Up to 60 ft.	2Ω	10 gauge
	4Ω	12 gauge
	8Ω	16 gauge
Up to 100 ft.	2Ω	8 gauge
	4Ω	10 gauge
	8Ω	14 gauge
Up to 150 ft.	2Ω	6 gauge
	4Ω	8 gauge
	8Ω	12 gauge
Up to 250 ft.	2Ω	4 gauge
	4Ω	6 gauge
	8Ω	10 gauge

### Stereo and Mono Modes Binding Posts

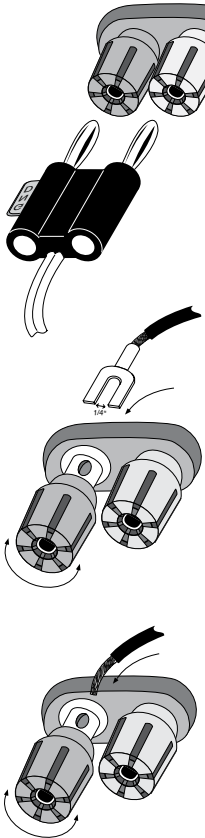

When using the binding post outputs in stereo or mono modes, you can terminate your speaker cables with single or double banana plugs, spade lugs, or leave them unterminated (bare wires): unscrew the amp's binding posts enough to reveal the holes on their sides, then insert your stripped wires (stripped about 3/8" back) into the holes and retighten the posts (finger tight is fine). Be careful that no runaway strands touch the chassis or other terminal.

The red posts are labeled "+," which means positive. The black posts are labeled "-" for negative. You probably know the importance of getting these correct – if one speaker is hooked up "in phase" and the other speaker is "out of phase," you'll be "out of work." (By the way, although everyone says "phase" in this situation, the correct word is "polarity.")

### Speakons

When using the Speakon outputs in stereo or mono modes, wire the Speakon connectors as shown below:

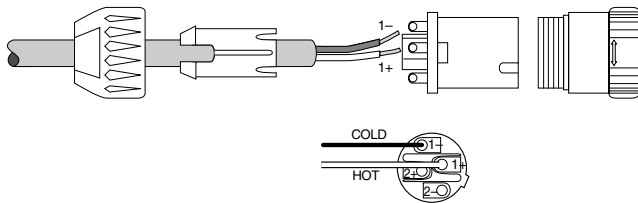

Stereo and Mono Speakon Connection

### Bridged Mode Binding Posts

When using the binding posts in bridge mode, connect the positive side of the speaker cable to the CHANNEL 1 red (+) binding post, and connect the negative side of the speaker cable to the CHANNEL 2 red (+) binding post. No, that's not a typo. **You only use the red binding posts in Bridged mode. Do not use the black posts.**

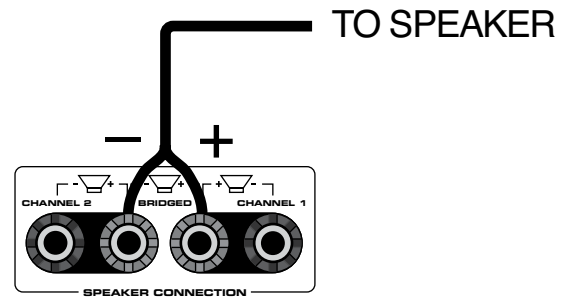

Bridged Binding Post Connection

Since bridged mode is a type of mono mode, turning a stereo amplifier into a single channel amplifier, use only the CHANNEL 1 input. Turn the CHANNEL 2 level control all the way down.

### Speakons

When using bridge mode, wire the Speakon connector as follows:

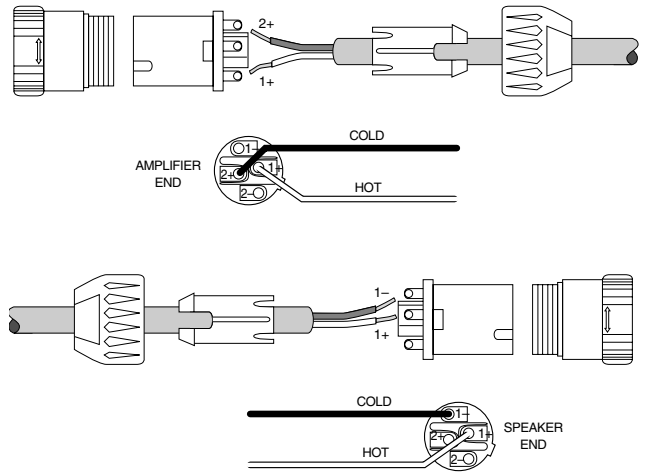

Bridged Speakon Connection

## Dual-Channel Connection

The BRIDGED connector has the added feature of providing both speaker outputs on a single connector. This allows you to use a single cable to carry both channels from the amplifier to the speakers.

Many speakers with Speakon connectors provide an Input connector and a “Thru” connector for connecting a second speaker in parallel. You can use the Thru connector to connect the CHANNEL 2 amplifier output to the CHANNEL 2 speaker.

In stereo mode, CHANNEL 1 output is available at Pins 1+ and 1-, and CHANNEL 2 is available at Pins 2+ and 2- on the BRIDGED connector. Wire all four pins in the Speakon connector, as shown below, at both ends of the cable. For the cable connecting the “Thru” connector to the second speaker, you need to use a “crossover” cable that connects pins 2+ and 2- on the “Thru” connector to pins 1+ and 1- on the second speaker input end.

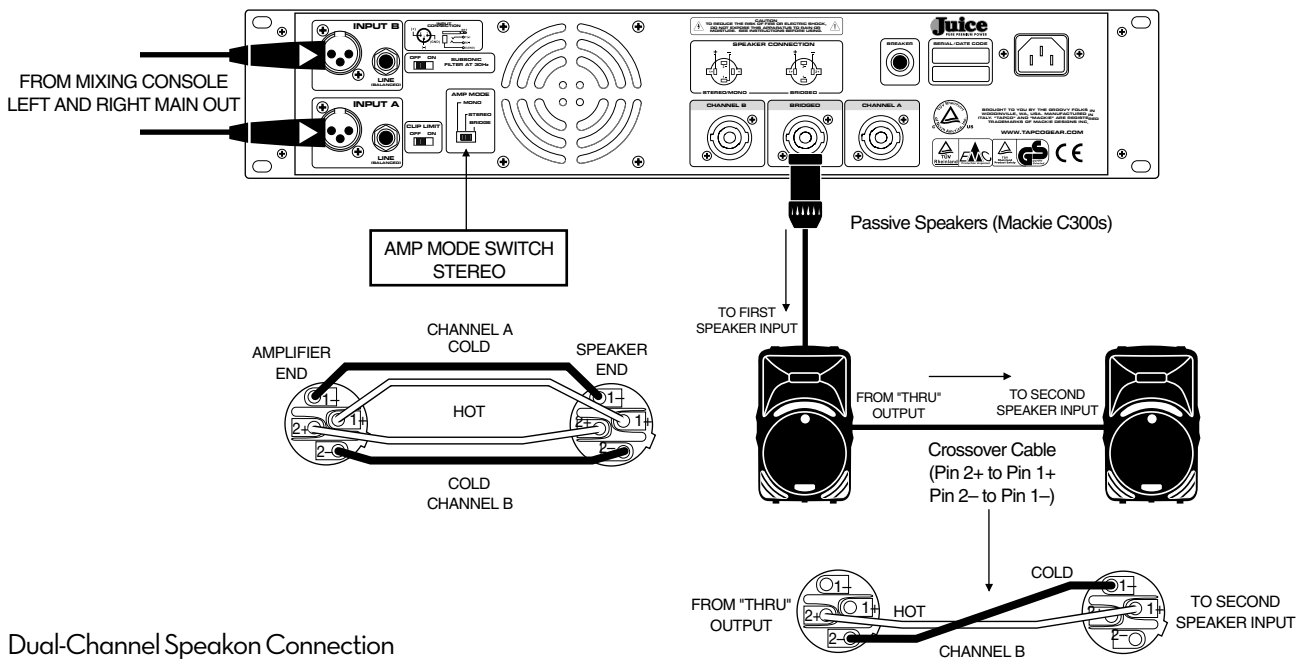

Dual-Channel Speakon Connection

# Appendix A: Service Information

## Warranty Service

Details concerning Warranty Service are spelled out in the Warranty section on page 19.

If you think your amplifier has a problem, please do everything you can to confirm it before calling for service. Doing so might save you from the deprivation of your amplifier and the associated suffering.

These may sound obvious to you, but here are some things you can check. Read on.

## Troubleshooting

### No Power

- Our favorite question: Is it plugged in? Make sure the AC outlet is live (check with a tester or lamp).
- Our next favorite question: Is the POWER switch on? If not, try turning it on.
- Is the red LED next to the POWER switch illuminated? If not, make sure the AC outlet is live. If so, refer to “No Sound” below.
- Has the BREAKER switch popped? Try pushing in the BREAKER switch. If it pops out again right away, refer to “Repair” on the next page.
- The AC fuse inside the amplifier is blown. This is not a user-serviceable part. Refer to “Repair” on the next page to find out how to proceed.

### No Sound

- Are the channel Level controls turned up? Slowly turn them up and see if you hear anything.
- Is the signal source turned up? Make sure the signal level from the mixing console (or whatever device immediately precedes the amplifier) is high enough to produce sound in the amplifier. The SIG LEDs should be blinking to indicate that signal is present.
- If the speakers are wired for BRIDGE mode, make sure the AMP MODE switch is set to BRIDGE.
- If the amplifier has gotten extremely hot, the thermal protection circuit may have activated. Allow the amplifier to cool down and normal operation should resume.
- Are there fuses in the speakers, or in-line fuses in the speaker wire? Check ‘em to see if they’re blown.
- Make sure the speakers are working properly.

### One side is way louder than the other

- Are both Level controls set to the same position?
- Check your source signal to make sure the left and right signals are balanced.
- Are the speaker impedances matched? Different speaker loads can cause different volume levels on each side.
- Try switching sides: Turn off the amp, swap the speaker cables at the amp, turn the amp back on. If the same side is still louder, the problem is with your speaker cabling. If the other side is louder now, the problem is with the mixer, the amp, or the line-level cabling.

### The stereo music sounds kind of sideways, and the bass frequencies diminish when standing center, but get louder as you approach one side

- Check the polarity of the speaker cable connections. You may have your positive and negative reversed at one end of one speaker cable.

### As soon as the music gets loud, the amp shuts down

- Check the OL LEDs and make sure that they are not lighting continuously. If they are, turn down the signal source or the Level controls on the amp.
- Can the amp breathe? The amplifier draws its ventilation air in from the back. It needs plenty of fresh air to stay cool. **Do not block the ventilation holes.**

### I hear thunder, even when the amplifier is turned off

- It’s going to rain. Get inside quickly. Bring the amplifier with you.

### Poor sound

- Is it loud and distorted? Turn down the signal coming from the mixer or signal source.
- Is the input connector plugged completely into the jack? Check the speaker connections and verify that all connections are tight and that there are no stray strands of wire shorting across the speaker terminals.
- If possible, listen to the signal source with headphones plugged into the console. If it sounds bad there, the problem is not in the amplifier.

## Noise/Hum

- Check the signal cable between the mixer and the amplifier. Make sure all connections are good and sound.
- Make sure the signal cable is not routed near AC cables, power transformers, or other EMI-inducing devices.
- Is there a light dimmer or other SCR-based device on the same AC circuit as the amplifier? Use an AC line filter, or plug the amplifier into a different AC circuit.
- If possible, listen to the signal source with headphones plugged into the console. If it sounds noisy there, the problem is not in the amplifier.

## Repair

Service for TAPCO amplifiers is available at a factory-authorized service center. Service for TAPCO amplifiers living outside the United States can be obtained through local dealers or distributors.

If your amplifier needs service, follow these instructions:

1. Review the preceding troubleshooting suggestions. Please.
2. Call Tech Support at 1-877-827-2669, 7 am to 5 pm PST, to explain the problem and obtain a Service Request Number. Have your amplifier's serial number ready.  
**You must have a Service Request Number before you can obtain factory-authorized.**
3. Keep this owner's manual and the detachable power cord. We don't need them to repair the amplifier.

4. Pack the amplifier in its original package, including endcaps and box. This is **VERY IMPORTANT**. When you call for the Service Request Number, please let Tech Support know if you need new packaging. You can order new packaging through our parts department. *TAPCO is not responsible for any damage that occurs due to non-factory packaging.*
5. Include a legible note stating your name, shipping address (no P.O. boxes), daytime phone number, RA number, and a detailed description of the problem, including how we can duplicate it.
6. Write the Service Request Number in **BIG PRINT** on top of the box. Units sent to us without the Service Request Number will be refused.
7. Tech Support will tell you where to ship the amplifier for repair. We suggest insurance for all forms of cartage.
8. We'll try to fix the amplifier within five business days. Ask Tech Support for the latest turn-around times when you call for your Service Request Number. The amplifier must be packaged in its original packing box, and must have the Service Request Number on the box. Once it's repaired, we'll ship it back the same way in which it was received. This paragraph does not necessarily apply to non-warranty repair.

**Note:** You must have a sales receipt from an Authorized TAPCO Dealer to qualify for a warranty repair.

### Lonely? Looking for that special someone? Do you have a question about your TAPCO Amplifier?

Please call our Technical Support folks at **1-877-827-2669**, Monday to Friday, from 7 am to 5 pm PST. After hours, visit [www.tapcogear.com](http://www.tapcogear.com) and look under **Support**, or e-mail us at [techmail@tapcogear.com](mailto:techmail@tapcogear.com)

# Appendix B: Technical Info

## Do The Math: Ohms, Loads, and Such

An ohm is a unit of resistance – the more ohms, the more resistance (or, more accurately in this case, impedance). The more the resistance, the less the power.

If you're dealing with just one speaker (or cabinet) per output, the load in ohms is usually printed on it somewhere. That's your load, usually 8 ohms or 4 ohms.

If you're driving an assortment of speakers, things can get complicated. There are two basic ways of linking multiple loads (or speakers in this case): series and parallel.

Since series connections are not normally used in PA applications, we'll concentrate on the parallel connection. Parallel means that the positive amp output connects to the positive terminals of all the speakers, and the negative amp output connects to the negative terminals of all the speakers. If one

speaker fails in a parallel configuration, the others will still work.

Calculating parallel loads is easy, as long as each speaker has the same value – just divide the value by the number of speakers. For instance, four 8-ohm speakers, connected in parallel, will equal 2 ohms ( $8/4 = 2$ ). If the loads are not all the same, the formula gets a little more complicated, but nothing that you can't do with a simple calculator.

$$Z_T = \frac{1}{\frac{1}{Z_1} + \frac{1}{Z_2} + \frac{1}{Z_3} + \dots}$$

Using this formula, an 8-ohm speaker and a 4-ohm speaker, connected in parallel, will equal 2.7 ohms. Remember that the Juice amplifiers require 2 ohms or greater per channel in Stereo or Mono mode, and 4 ohms or greater in Bridge mode.



# Juice Series Specifications

## Continuous Sine Wave Average Output Power for each channel with both channels driven, 20 Hz to 20 kHz

	J-800	J-1400	J-2500
2 ohms:	480 W	800 W	1400 W
4 ohms:	300 W	450 W	750 W
8 ohms:	205 W	310 W	575 W

## Bridged Mono Operation, 20 Hz to 20 kHz

	J-800	J-1400	J-2500
4 ohms:	800 W	1400 W	2500 W
8 ohms:	560 W	900 W	1500 W

**Note:** Power ratings are specified at 120 VAC line voltage.

## Power Bandwidth

5 Hz to 50 kHz (+0, -3 dB)

## Frequency Response

25 Hz to 25 kHz (+0, -1 dB)

## Distortion

THD and SMPTE IMD; 20Hz to 20kHz  
< 0.03% @ 8 ohms

## Signal-to-Noise Ratio

> 100 dB below rated power into 4 ohms

## Channel Separation

> 90 dB @ 1 kHz

## Damping Factor

> 300 @ 1 kHz and below

## Input Impedance

20 k· balanced  
10 k· unbalanced

## Input Sensitivity

1.15 V (+3.4 dBu) for rated power into 4 ohms

## Gain

J-800:	30 dB
J-1400:	32 dB
J-2500:	34 dB

## Maximum Input Level

9.75 Vrms (+22 dBu)

## Turn On Delay

2.5 seconds

## Subsonic Filter

- 9 dB @ 30 Hz

## Topology

J-800, J-1400:	Class AB
J-2500:	Class H

## Cooling

Dual variable-speed fans with back to front airflow

## Indicators

Channels A and B  
SIG (Signal Present), OL (Overload)  
POWER

## Current Consumption

	J-800	J-1400	J-2500
Idle	0.5 A	0.5 A	1.0 A
Musical Program @ 8-	3.9 A	5.1 A	8.1 A
Musical Program @ 4-	5.0 A	6.7 A	10.0 A
Musical Program @ 2-	7.0 A	10.6 A	17.2 A

## AC Power Requirements

U.S.	120 VAC, 60 Hz
Europe	240 VAC, 50 Hz
Japan	100 VAC, 50/60 Hz
Korea	220 VAC, 60 Hz

## Physical Dimensions and Weight

Height:	3.5 in/89 mm
Width:	19.0 in/483 mm
Depth:	15.7 in/400 mm
Weight:	
J-800:	43.6 lb/19.8 kg
J-1400:	48.5 lb/22.0 kg
J-2500:	56.2 lb/25.5 kg

## Disclaimer

Since we are always striving to make our products better by incorporating new and improved materials, components, and manufacturing methods, we reserve the right to change these specifications at any time without notice.

“TAPCO” is a registered trademark of LOUD Technologies Inc. “Juice” is a trademark of LOUD Technologies Inc.

All other brand names mentioned are trademarks or registered trademarks of their respective holders, and are hereby acknowledged.

©2003-2005 LOUD Technologies Inc. All Rights Reserved.

# Juice Series Block Diagram

This shows an outline of the interesting things going on inside the amplifier.

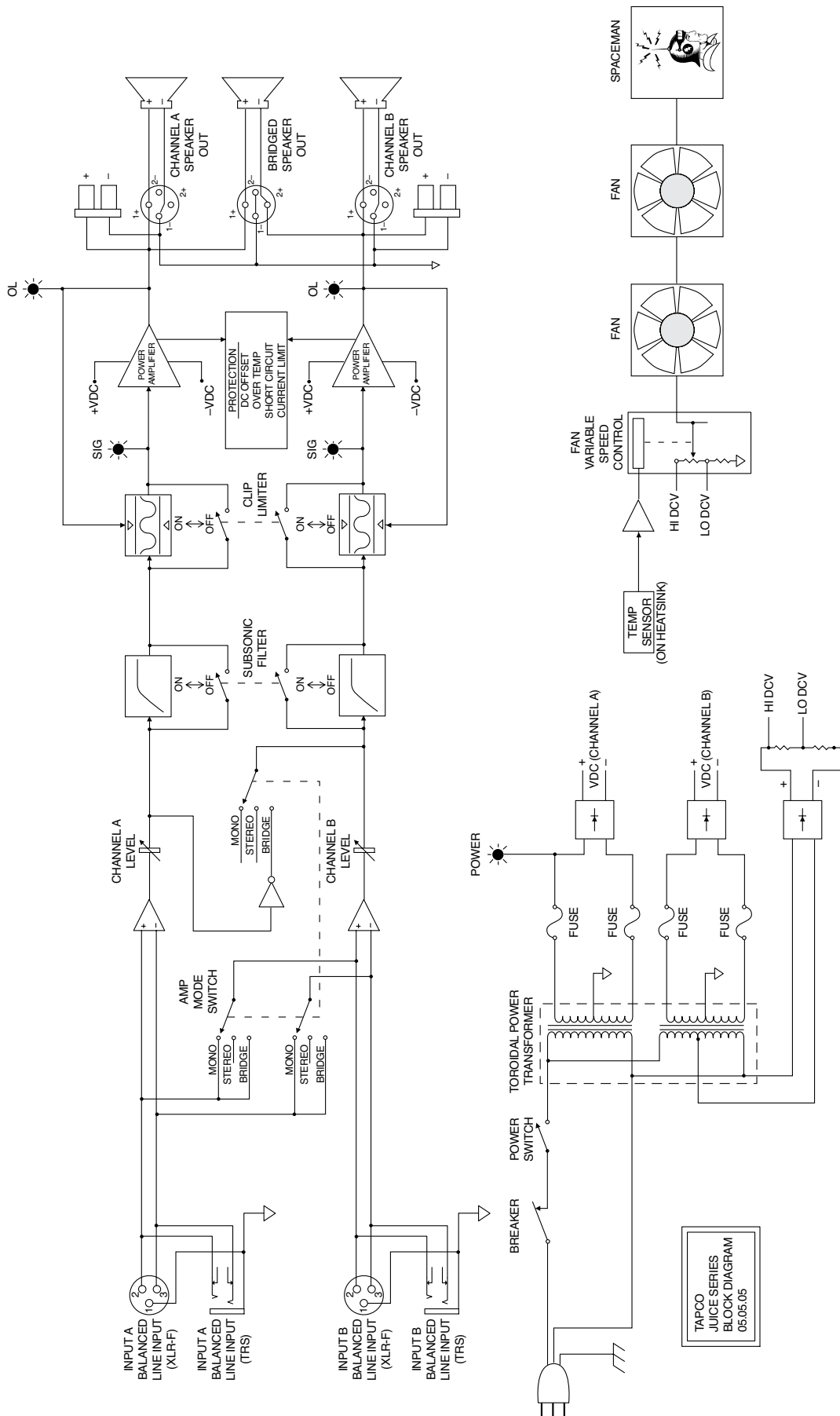

# TAPCO LIMITED WARRANTY

- A.** LOUD Technologies Inc. warrants all materials, workmanship and proper operation of this TAPCO product for a period of **one year** from the original date of purchase. If any defects are found in the materials or workmanship, or if the product fails to function properly during the applicable warranty period, LOUD Technologies, at its option, will repair or replace the product. **This warranty applies only to equipment sold and delivered within the U.S. by LOUD Technologies or its authorized dealers.**
- B.** Failure to register online or return the product registration card will not void the one-year warranty.
- C.** Service and repairs of TAPCO products are to be performed **only** at a factory-authorized service center. Unauthorized service, repairs, or modification will void this warranty. To obtain repairs under warranty, you must have a copy of your sales receipt from the authorized TAPCO dealer where you purchased the product. It is necessary to establish purchase date and determine whether your TAPCO product is within the warranty period.
- D.** To obtain factory-authorized service:
- 1.** Call TAPCO Technical Support at 877/827-2669, 7 AM to 5 PM Monday through Friday (Pacific Time) to get a Service Request Number. Products returned without a Service Request Number will be refused.
  - 2.** Pack the product in its original shipping carton. Also include a note explaining exactly how to duplicate the problem, a copy of the sales receipt with price and date showing, and your return street address (no P.O. boxes or route numbers, please!). If we cannot duplicate the problem or establish the starting date of your Limited Warranty, we may, at our option, charge for service time.
  - 3.** Ship the product in its original shipping carton, **freight prepaid**, to the authorized service center. The address of your closest authorized service center will be given to you by Technical Support.
- IMPORTANT: Make sure that the Service Request Number is plainly written on the shipping carton.**
- E.** LOUD Technologies Inc. reserves the right to inspect any products that may be the subject of any warranty claims before repair or replacement is carried out. LOUD Technologies may, at our option, require proof of the original date of purchase in the form of a dated copy of the original dealer's invoice or sales receipt. Final determination of warranty coverage lies solely with LOUD Technologies Inc.
- F.** TAPCO products returned to one of the LOUD Technologies factory-authorized service centers and deemed eligible for repair or replacement under the terms of this warranty will be repaired or replaced within thirty days of receipt. LOUD Technologies and its authorized service centers may use refurbished parts for repair or replacement of any product. Products returned to LOUD Technologies that do not meet the terms of this Warranty will not be repaired unless payment is received for labor, materials, return freight, and insurance. Products repaired under warranty will be returned freight prepaid by LOUD Technologies to any location within the boundaries of the USA.
- G.** LOUD Technologies warrants all repairs performed for 90 days or for the remainder of the original warranty period. This warranty does not extend to damage resulting from improper installation, misuse, neglect or abuse, or to exterior appearance. This warranty is recognized only if the inspection seals and serial number on the unit have not been defaced or removed.
- H.** LOUD Technologies assumes no responsibility for the quality or timeliness of repairs performed by Authorized TAPCO Service Centers.
- I.** This warranty is extended to the original purchaser and to anyone who may subsequently purchase this product within the applicable warranty period. A copy of the sales receipt is required to obtain warranty repairs.
- J.** This is your sole warranty. LOUD Technologies Inc. does not authorize any third party, including any dealer or sales representative, to assume any liability on behalf of LOUD Technologies or to make any warranty for LOUD Technologies Inc.
- K.** THE WARRANTY GIVEN ON THIS PAGE IS THE SOLE WARRANTY GIVEN BY LOUD TECHNOLOGIES INC. AND IS IN LIEU OF ALL OTHER WARRANTIES, EXPRESS AND IMPLIED, INCLUDING THE WARRANTIES OF MERCHANTABILITY AND FITNESS FOR A PARTICULAR PURPOSE. THE WARRANTY GIVEN ON THIS PAGE SHALL BE STRICTLY LIMITED IN DURATION TO ONE YEAR FROM THE DATE OF ORIGINAL PURCHASE FROM AN AUTHORIZED TAPCO DEALER. UPON EXPIRATION OF THE APPLICABLE WARRANTY PERIOD, LOUD TECHNOLOGIES INC. SHALL HAVE NO FURTHER WARRANTY OBLIGATION OF ANY KIND. LOUD TECHNOLOGIES INC. SHALL NOT BE LIABLE FOR ANY INCIDENTAL, SPECIAL, OR CONSEQUENTIAL DAMAGES THAT MAY RESULT FROM ANY DEFECT IN THE TAPCO PRODUCT OR ANY WARRANTY CLAIM. Some states do not allow exclusion or limitation of incidental, special, or consequential damages or a limitation on how long warranties last, so some of the above limitations and exclusions may not apply to you. This warranty provides specific legal rights and you may have other rights which vary from state to state.



tapcogear.com